

FENA SLEEPING





FENA SLEEPING

Stay in bed and hang onto your dreams – FENA gives the room a deliberately laid back feel: The design offers a balanced mix of style and tidiness, it combines very different materials in clear, gentle lines. Pure white and silky grey welcome the day, robust planked oak provides natural charm, concrete grey and bronze add modern accents. FENA combines beauty with sophistication to ensure restful comfort.

Contents

	Page
Range introduction, lists of versions	2-3
Special combinations	4
Hinge-door wardrobes, design intermediate unit	5-7
Bed systems	8-9
Ancillary units	10-11
Angled shelves, radio remote control	12
General information:	
Usable bed inside height and space under bed	13
Special-sized products, special articles	14-15
Important notes: quality of walls / assembly instruction	16

Wardrobes

Height reductions at intervals of 1.0 cm without surcharge

Hinge-door wardrobes according to the endless assembly principle

- All hinge-doors plain, with optional mirror (surcharge)
- With optional top LED lamp (12 V; 2.4 W)
- Design intermediate unit for a more open look
- Wardrobe interior carcass and wardrobe interior fittings in standard white lacquer version
- Standard interior fittings: 2 fitted shelves. 1 clothes rod
- Functional and high-quality **wardrobe interior fittings** (see "Wardrobe interior fittings" type list)

Beds

- Beds with straight headboard, optionally with headboard application or with upholstered headboard
- Beds with profiled headboard, optionally with upholstered headboard roll or with upholstered headboard
- All upholstered components in three artificial leather versions, optionally in vintage grey beige, vintage brown or vintage dark grey

In combination with the hülsta Sleeping System, the beds guarantee highest sleeping comfort. With its high-quality spring base frames and mattresses, the hülsta Sleeping System provides the perfect prerequisites for relaxing sleep (see "**SLEEPING SYSTEMS**" type list).

Ancillary units

- Consoles and panel consoles in two widths
- Chests in four widths
- Interior carcass and interior fittings of the ancillary units in standard pure white lacquer version (exception: consoles)
- Angled shelves in three widths, with optional lamp

Quality features

- Wardrobe doors with handle and high-quality spring hinges
- Visually unobtrusive 2.5 mm drilled holes for wardrobes
- Centre partitions and end side-sections of wardrobes with special plinth adjustment
- **hülsta-SoftFlow**: Drawers of ancillary units on hidden bearings incl. auto pull-in feature with cushioning device
- **hülsta-MagicClose**: All wooden hinge-doors with door hinge cushioning device

Lists of versions

Model no.	Carcase and front	Price group	Model no.	Accent
NEW 648 663 695	Pure white lacquer Silk grey lacquer Planked oak	I I II	NEW 656 672	Concrete grey Bronze
Note: Wardrobe interior carcass and wardrobe interior fittings in standard white lacquer, interior carcass and interior fittings of ancillary units in standard pure white lacquer (exception: consoles).			Note: The concrete grey and bronze accent versions are only available for chosen components of the design intermediate unit and for cover shelves of consoles and chests. These are specially marked.	

Exchanging versions for wardrobes:

With FENA units you can choose the carcass and front in different versions. Please state the parts in a changed colour in the order. If versions from different price groups are exchanged the higher price group is always charged.

Exchanging versions for ancillary units:

With FENA units you can choose the cover shelf in a different version (without surcharge). Please state clearly in the order!

Versions of handles and bed legs

Handle versions

Handles optionally in high-gloss chrome or antique silver

Bed leg versions

Bed legs optionally in high-gloss chrome, antique silver or bronze

Please state all the required versions clearly in the order!

Versions of upholstered headboard roll and upholstered headboard

Type of material	Material identification
Artificial leather no.	Colour
Artificial leather S700 S701 S702	top: 100% polyurethane; below: 70% polyester, 30% cotton vintage grey beige vintage brown vintage dark grey

Please state the required version clearly in the order!

Labelling in type list drawings / assembly notes for wall units

Labelling in type list drawings / assembly notes for wall units

The majority of units have two wall mounting points (= number of base plates), if these are to be fitted as wall units. This is not explicitly mentioned in the type list. If a different number of wall mounting points (= base plates) is required, this is marked in the drawings in the type list with numbers in black boxes. Please be sure to note here the information and notes in the "Wall composition" chapter!

3
4

Notes on delivery

Notes on delivery:

The majority of the units are delivered standard as **fully connected units (glued)** so that the carcass **cannot be disassembled**. There are however some **exceptions** to this rule:

Some carcasses are delivered as complete units but can be **disassembled into individual sections** in the final customer's home. These types are marked with a **1** in the type list.

Some carcasses are delivered **in individual sections** because of their size. These types are marked with a **2** in the type list.

The fronts with the number **2** are delivered separately and can therefore always be (dis-) assembled.

Wall fitting

Important notes: Generally speaking, you as a dealer/qualified fitter are responsible for the correct wall mounting of the units. That is why wall mounting should only be carried out by properly trained and qualified fitters. hülsta supplies materials for mounting units on walls for nearly all the units and which should be used for safety and for constructional reasons. The assembly materials supplied by hülsta (plugs, screws) are only suitable for fitting components on to concrete in firmness class C12/15. For other materials (please see separate materials table in the wall composition chapter) we provide you with an assembly mortar set as an extra order. Please note that this assembly mortar set is also only suitable for the materials listed in the materials table. If walls are made up of other materials (e.g. plastered or lighter wall materials), one should use another method of mounting better suited to the load on site. Please note that if the units are not mounted properly on the wall, there is a risk of the units falling down or tipping over – especially when alternative mounting materials acquired on site have been used. For the reasons stated above it is absolutely essential to enquire about the composition of any walls before signing any contracts.

Special combinations

Please also note the mattresses and base frames in the "Sleeping systems" type list!

Please state the required handle version clearly in the order!

Special combinations are arrangements that are reduced in price. This price advantage is only available when the arrangement is ordered exactly as described. The special combinations can be enhanced by including accessories. These are charged extra.

Special combinations consisting of a bed unit (bed with two drawer consoles) and a hinge-door wardrobe.

The price of an entire special combination (bed unit and wardrobe) can be found in the grey shaded boxes!

Note: All the illustrations show the bed with the depth-profiled headboard.

Special-sized products for special combinations are possible! **Pricing:** special combination + 15% plus all the required special-sized products (see here „Special-sized products“!)

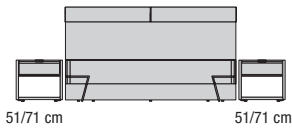

or

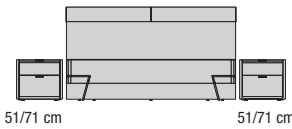

or

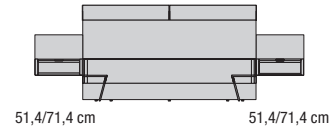

Important: Choose a bed (all beds and bed sizes are possible – please state the type number; see pages 8-9), two consoles (all types of consoles are possible – please state the type number; see page 10) as well as one of the wardrobes listed below.

		Price of an entire special combination (bed unit and wardrobe)	Surcharge for wardrobe lamps per unit: 1 top LED lamp	Surcharge for console lamps Surcharge for both consoles
Notes on the energy class: see pages 5 and 10!				
4-door hinge-door wardrobe 202 cm wide		A8406 Price gr. I - II -	0383 -	3023 -
5-door hinge-door wardrobe 252 cm wide	<p>(centre door with right hinges)</p>	A8416 Price gr. I - II -	0385 -	3023 -
5-door hinge-door wardrobe 252 cm wide	<p>(centre doors with right hinges)</p>	A8437 Price gr. I - II -	0385 -	3023 -
6-door hinge-door wardrobe 302 cm wide		A8436 Price gr. I - II -	0385 -	3023 -

Notes on planning hinge-door wardrobes according to the endless assembly principle

Hinge-door wardrobes can be planned endlessly and combined with one another. Due to the various element widths one can create many total wardrobe widths. In this way the available floor space can be exploited to the full. For each wardrobe combination, the first element on the left is considered to be the basic unit, incorporating both outer side-sections. One can only include one basic unit in each combination. When adding on extension units, the right-hand side-section of the basic unit is employed as the end side-section of the complete combination. In the case of single-door hinge-door units one can choose between left- and right-hand hinges. The graphics shown below give you an excerpt from our wardrobe assortment.

Standard interior fittings per unit: 2 fitted shelves, 1 clothes rod.
All interior surfaces are in white lacquer.

Dimensions

	Wardrobe height	Wardrobe height with top LED lamp
Heights incl. plinth:	229.6 cm	234.6 cm
	Height reductions at intervals of 1.0 cm without surcharge	
Depths:	61.4 cm	74.2 cm
Widths:	see pages 6-7	

Wardrobe examples

4-door hinge-door wardrobe with integrated design intermediate unit 252 cm wide

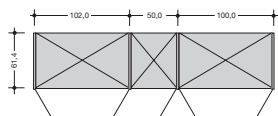
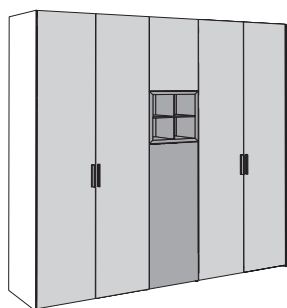

6-door hinge-door wardrobe 302 cm wide

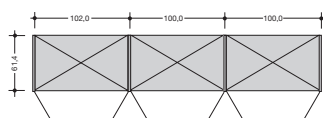
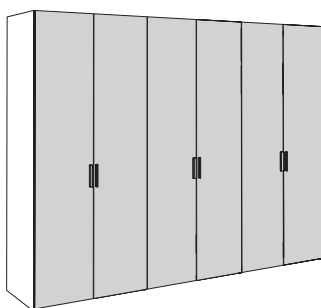

Hinge-door wardrobes

- Hinge-door wardrobes can be planned endlessly and combined with one another
- Design intermediate unit for a more open look
- Handles optionally in high-gloss chrome or antique silver
- Front mirrors and lamps against surcharge
- Unit outside widths: 42, 52, 82, 102 cm (basic units)
- 40, 50, 80, 100 cm (extension units)
- Unit inside widths: 38, 48, 78, 98 cm
- Outside depth: 61.4 cm
- Inside depth: 56 cm
- Door opening angle: approx. 94°

Lamps

All hinge-door wardrobes are available with optional top LED lamps. One top LED lamp (12 V, 2.4 W) is fitted standard above each element – 1 or 2 door. If required, a top LED lamp can be fitted centrally above each door. Please include a sketch in all cases. Switching is done by an external footswitch. A remote control unit is also available as an alternative, which is charged extra. The remote control unit incorporates one transmitter and one receiver which operate all the LED lamps. The footswitch is omitted when the remote control unit is employed.

Remote control

Surcharge for remote control (transmitter + receiver) type



1601 = -

Surcharge for extra transmitter type

1602 = -

Surcharge for extra receiver type

1603 = -

Top LED lamp

Surcharge for each additional lamp (2.4 W) type

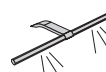



369 = -

This luminaire contains built-in LED lamps of the energy classes A++ to A. The lamps cannot be changed in the luminaire. 12 V

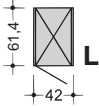
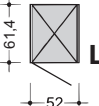
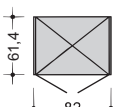
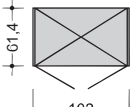
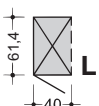
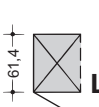
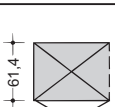
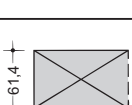

Hinge-door wardrobes

For each project please remember to leave a 2 cm gap to the ceiling and at the side for assembly!

Hinge-door wardrobes		Doors with flush front	Surcharge for top LED lamp	Surcharge for mirror
<p>Height: 229.6 cm (height with top LED lamp: 234.6 cm); height reductions at intervals of 1.0 cm without surcharge)</p> <p>Width: see table</p> <p>Depth: 61.4 cm (depth with top LED lamp: 74.2 cm)</p> <p>Interior fittings per unit: 2 fitted shelves, 1 clothes rod; interior fittings always in white lacquer.</p> <p>All hinge-doors with handle. Handles in high-gloss chrome or antique silver, see here the information on page 3.</p>			<p>1 lamp per unit</p>  <p>Information on the energy class and further information on lamps: see page 5!</p>	<p>Each wardrobe door can be optionally fitted with a mirror (vertical facette) for which a surcharge is made.</p> 
<p>Basic units with 2 outer side-sections (each 2 cm thick)</p> <p>For each wardrobe combination, the first element on the left is considered to be the basic unit, incorporating both outer side-sections. One can only include one basic unit in each combination. When adding on extension units, the right-hand side-section is employed as the end side-section.</p>				
	<p>Single-door unit, left or right, 42 cm wide</p>	<p>Price gr.</p> <p>I</p> <p>II</p>	<p>A02011 L A02012 R</p> <p>-</p> <p>-</p>	<p>380</p> <p>-</p> <p>-</p>
	<p>Single-door unit, left or right, 52 cm wide</p>	<p>Price gr.</p> <p>I</p> <p>II</p>	<p>A2011 L A2012 R</p> <p>-</p> <p>-</p>	<p>380</p> <p>-</p> <p>-</p>
	<p>Twin-door unit, 82 cm wide</p>	<p>Price gr.</p> <p>I</p> <p>II</p>	<p>A0202</p> <p>-</p> <p>-</p>	<p>380</p> <p>-</p> <p>-</p>
	<p>Twin-door unit, 102 cm wide</p>	<p>Price gr.</p> <p>I</p> <p>II</p>	<p>A202</p> <p>-</p> <p>-</p>	<p>380</p> <p>-</p> <p>-</p>
<p>Extension units with 1 centre partition (2 cm thick)</p>				
	<p>Single-door unit, left or right, 40 cm wide</p>	<p>Price gr.</p> <p>I</p> <p>II</p>	<p>A00011 L A00012 R</p> <p>-</p> <p>-</p>	<p>382</p> <p>-</p> <p>-</p>
	<p>Single-door unit, left or right, 50 cm wide</p>	<p>Price gr.</p> <p>I</p> <p>II</p>	<p>A0011 L A0012 R</p> <p>-</p> <p>-</p>	<p>382</p> <p>-</p> <p>-</p>
	<p>Twin-door unit, 80 cm wide</p>	<p>Price gr.</p> <p>I</p> <p>II</p>	<p>A0002</p> <p>-</p> <p>-</p>	<p>382</p> <p>-</p> <p>-</p>
	<p>Twin-door unit, 100 cm wide</p>	<p>Price gr.</p> <p>I</p> <p>II</p>	<p>A002</p> <p>-</p> <p>-</p>	<p>382</p> <p>-</p> <p>-</p>

Please state the required handle version clearly in the order!

Design intermediate unit

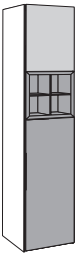
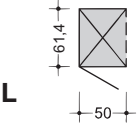
<p>Design intermediate unit</p> <p>Height: 229.6 cm (height with top LED lamp: 234.6 cm); height reductions (possible up to a total height of 201 cm) at intervals of 1.0 cm without surcharge.</p> <p>Width: 50.0 cm (width reductions not possible)</p> <p>Depth: 61.4 cm (depth with top LED lamp: 74.2 cm; depth reductions not possible)</p> <p>Design intermediate unit is not possible as a stand-alone unit.</p> <p>Interior fittings per unit: 3 fitted shelves; interior fittings always in white lacquer.</p>	<p>Doors with flush front</p> 	<p>Surcharge for top LED lamp</p> <p>1 lamp per unit</p>  <p>Information on the energy class and further information on lamps: see page 5!</p>	
<p>Design intermediate unit with 1 centre partition (2 cm thick)</p>			
 <p>Open compartment incl. divisions and lower door (always in the same version) optionally available in the concrete grey and bronze versions (no surcharge). Please state clearly in the order!</p>   <p>Design intermediate unit</p> <p>with 2 doors (without handle) with hülsta-Push-to-open and open compartment incl. divisions</p> <p>Inside width: 48.0 cm; inside depth: 56.5 cm</p>	<p>Price gr.</p> <p>I</p> <p>II</p>	<p>A07101 L A07102 R</p> <p>-</p> <p>-</p>	<p>382</p> <p>-</p>

Lamps

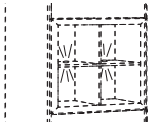
 <p>LED compartment lamps for design intermediate unit</p> <p>Set of 2; 2x 1.0 W</p> <p>LED lamps incl. foot switch. A radio remote control is possible for operation (against a surcharge).</p> <p>This luminaire contains built-in LED lamps of the energy classes A++ to A. The lamps cannot be changed in the luminaire. 12 V</p>	<p>508</p> <p>-</p>
---	----------------------------

Beds with straight headboard

Please also note the mattresses and base frames in the “Sleeping systems” type list!

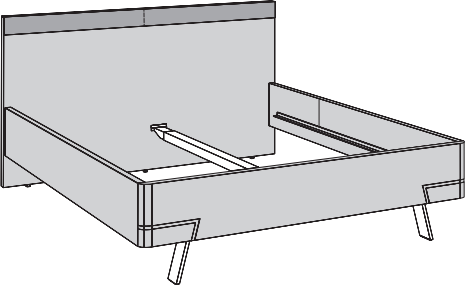
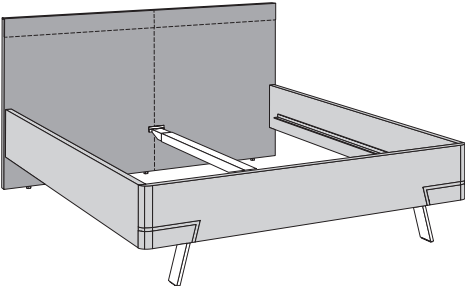
Bed with straight headboard and application Application in artificial leather, optionally vintage grey beige, vintage brown or vintage dark grey. Bed legs optionally in high-gloss chrome, antique silver or bronze, see here the information on page 3.	Inside dims.	Outside dims.	Type no.	Price group I	Price group II
<p>Beds incl. support slats for base frames and mattresses</p> <ul style="list-style-type: none"> • Adjustable in height by 3.2 cm downwards and upwards • Usable bed inside height: max. 18.0 cm <p>Please state all the versions clearly in the order!</p>  <p>Bed sizes: Headboard height: 95.5 cm Height of top rim of bed side: 45.5 cm Space to floor: 19.3 cm Usable bed inside height (when support slats in bottom position): 18.0 cm</p>	140x200 160x200 180x200 200x200	148x208.3 168x208.3 188x208.3 208x208.3	625 626 627 628	- - - -	- - - -
<p>Bed with straight upholstered headboard Upholstered headboard in artificial leather, optionally vintage grey beige, vintage brown or vintage dark grey. Bed legs optionally in high-gloss chrome, antique silver or bronze, see here the information on page 3.</p> <p>Beds incl. support slats for base frames and mattresses</p> <ul style="list-style-type: none"> • Adjustable in height by 3.2 cm downwards and upwards • Usable bed inside height: max. 18.0 cm <p>Please state all the versions clearly in the order!</p>  <p>Bed sizes: Headboard height: 95.5 cm Height of top rim of bed side: 45.5 cm Space to floor: 19.3 cm Usable bed inside height (when support slats in bottom position): 18.0 cm</p>	140x200 160x200 180x200 200x200	148x208.3 168x208.3 188x208.3 208x208.3	6254 6264 6274 6284	- - - -	- - - -

Beds with depth profiled headboard

Please also note the mattresses and base frames in the "Sleeping systems" type list!



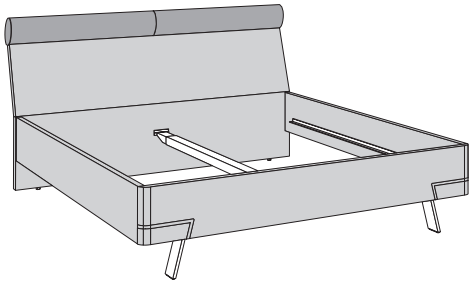
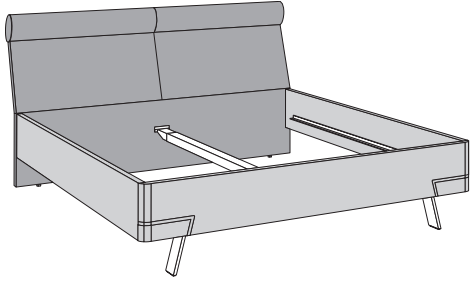

FENA

Bed with depth profiled headboard and upholstered headboard roll Upholstered headboard roll in artificial leather, optionally vintage grey beige, vintage brown or vintage dark grey. Bed legs optionally in high-gloss chrome, antique silver or bronze, see here the information on page 3.	Inside dims.	Outside dims.	Type no.	Price group I	Price group II
<p>Beds incl. support slats for base frames and mattresses</p> <ul style="list-style-type: none"> • Adjustable in height by 3.2 cm downwards and upwards • Usable bed inside height: max. 18.0 cm <p>Please state all the versions clearly in the order!</p>  <p>Bed sizes: Headboard height: 104.0 cm Height of top rim of bed side: 45.5 cm Space to floor: 19.3 cm Usable bed inside height (when support slats in bottom position): 18.0 cm</p>	140x200 160x200 180x200 200x200	149x227.5 169x227.5 189x227.5 209x227.5	825 826 827 828	- - - -	- - - -
<p>Bed with depth profiled upholstered headboard Upholstered headboard in artificial leather, optionally vintage grey beige, vintage brown or vintage dark grey. Bed legs optionally in high-gloss chrome, antique silver or bronze, see here the information on page 3.</p> <p>Beds incl. support slats for base frames and mattresses</p> <ul style="list-style-type: none"> • Adjustable in height by 3.2 cm downwards and upwards • Usable bed inside height: max. 18.0 cm <p>Please state all the versions clearly in the order!</p>  <p>Bed sizes: Headboard height: 104.0 cm Height of top rim of bed side: 45.5 cm Space to floor: 19.3 cm Usable bed inside height (when support slats in bottom position): 18.0 cm</p>	140x200 160x200 180x200 200x200	149x227.5 169x227.5 189x227.5 209x227.5	8254 8264 8274 8284	- - - -	- - - -

Consoles

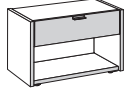

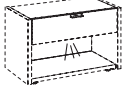
Cover shelf of the consoles and chests optionally available in **concrete grey** and **bronze** versions (without surcharge). Please state clearly in the order!

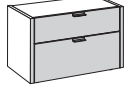
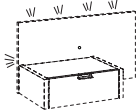
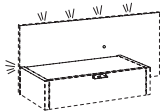
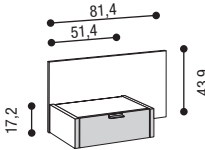
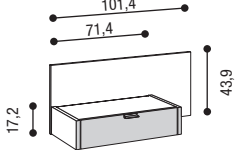
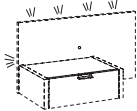
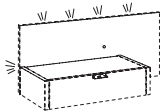
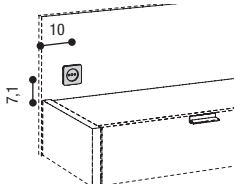
<p>Consoles on 1.8 cm high plinth adjusters; 45.5 cm high 45.0 cm deep</p> <p>Handles: See here the information on page 3.</p> <p>LED lamps for open compartment of the consoles LED lamps incl. foot switch</p> <p>This luminaire contains built-in LED lamps of the energy classes A+++ to A. The lamps cannot be changed in the luminaire. 12 V</p>	1 drawer; 1 open compartment	1 drawer; 1 open compartment	LED lamps for open compartment of the consoles	
	 <p>51.0 cm wide</p>	 <p>71.0 cm wide</p>	<p>1.7 W</p>  <p>for 51.0 cm width</p>	<p>1.7 W</p>  <p>for 71.0 cm width</p>
<p>Price gr.</p> <p>I</p> <p>II</p>	<p>5102</p> <p>-</p> <p>-</p>	<p>5112</p> <p>-</p> <p>-</p>	<p>504</p> <p>-</p>	<p>505</p> <p>-</p>
<p>Panel consoles Panel: 3.2 cm thick; console: 45.0 cm deep; total depth: 48.2 cm</p> <p>Wall assembly necessary</p> <p>Handles: See here the information on page 3.</p> <p>For the bed with depth-profiled headboard, the protruding panel section of the consoles is pushed into the bed headboard. For the bed with the straight headboard, the bed is placed in front of the protruding panel section. This increases the total depth by 5.7 cm.</p> <p>The panel consoles may only be fitted on absolutely solid walls. Gypsum or other light masonry is not suitable for this purpose. Please be sure to note here the information and notes in the "Wall composition" chapter!</p> <p>LED lamps for panel consoles LED lamps with switch in panel</p> <p>This luminaire contains built-in LED lamps of the energy classes A+++ to A. The lamps cannot be changed in the luminaire. 12 V</p>	2 drawers	2 drawers	LED lamps for panel consoles	
	 <p>51.0 cm wide</p>	 <p>71.0 cm wide</p>	<p>5.1 W</p>  <p>for 81.4 cm width</p>	<p>6.0 W</p>  <p>for 101.4 cm width</p>
<p>Price gr.</p> <p>I</p> <p>II</p>	<p>5002</p> <p>-</p> <p>-</p>	<p>5012</p> <p>-</p> <p>-</p>	<p>506</p> <p>-</p>	<p>507</p> <p>-</p>
<p>Electric socket for panels Position of electric socket (centre of socket): see here the sketch on the right. Later fitting is not possible.</p>	1 drawer	1 drawer	LED lamps for panel consoles	
	 <p>81.4 cm wide</p>	 <p>101.4 cm wide</p>	<p>5.1 W</p>  <p>for 81.4 cm width</p>	<p>6.0 W</p>  <p>for 101.4 cm width</p>
<p>as illustr. v. versa</p> <p>Price gr.</p> <p>I</p> <p>II</p>	<p>52021 52022</p> <p>-</p> <p>-</p>	<p>52121 52122</p> <p>-</p> <p>-</p>	<p>506</p> <p>-</p>	<p>507</p> <p>-</p>
<p>Electric socket for panels Position of electric socket (centre of socket): see here the sketch on the right. Later fitting is not possible.</p>			LED lamps for panel consoles	
	<p>06</p> <p>-</p>		<p>506</p> <p>-</p>	

Chests

Please state the required handle version clearly in the order!

Notes on delivery:
Please see here the information on range introduction pages.

1
2

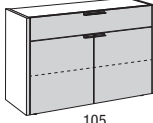
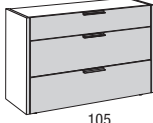
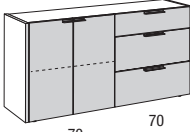
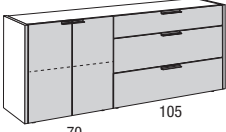
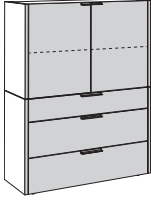
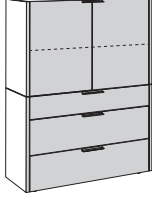

FENA

<p>Chests on 1.8 cm high plinth adjusters; 73.6 cm high 45.0 cm deep</p> <p>Handles: See here the information on page 3.</p>	<p>1 drawer, 2 doors</p>  <p>105 111.0 cm wide</p>	<p>3 drawers</p>  <p>105 111.0 cm wide</p>	<p>2 doors; 3 drawers</p>  <p>70 70 146.2 cm wide</p>	<p>2 doors; 3 drawers</p>  <p>70 105 181.4 cm wide</p>
	<p>as illustr. v. versa</p> <p>Price gr. I II</p>	<p>41113</p> <p>- -</p>	<p>41111</p> <p>- -</p>	<p>414131 414132</p> <p>- -</p>
<p>Chests on 1.8 cm high plinth adjusters; 145.6 cm high 45.0 cm deep</p> <p>Handles: See here the information on page 3.</p>	<p>2 doors; 3 drawers</p>  <p>111.0 cm wide</p>	<p>2 doors; 1 flap (centre), 2 drawers</p>  <p>111.0 cm wide</p>		
	<p>Price gr. I II</p>	<p>8103</p> <p>- -</p>	<p>8108</p> <p>- -</p>	

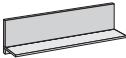
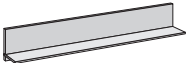
Angled shelves

<p>Angled shelves 19.2 cm high 19.7 cm deep</p> <p>for fitting anywhere on walls</p> <p>Max. load: 15 kg</p> <p>LED lamps for angled shelves: see below</p> <p>The angled shelves may only be fitted on absolutely solid walls. Gypsum or other light masonry is not suitable for this purpose. Please be sure to note here the information and notes in the "Wall composition" chapter!</p>				
		50.0 cm wide	70.0 cm wide	120.0 cm wide
	550	570	5100	
Price gr.	-	-	-	
II	-	-	-	

LED lamps for angled shelves

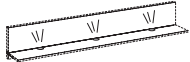
<p>LED lamps for angled shelves</p> <p>LED lamps incl. foot switch; radio remote control (see below) possible at a surcharge.</p> <p>This luminaire contains built-in LED lamps of the energy classes A++ to A. The lamps cannot be changed in the luminaire. 12 V; 1 W per lamp</p>				
		for 50.0 cm width	for 70.0 cm width	for 120.0 cm width
	501	502	503	
	-	-	-	

Remote control

Switching is done by an external footswitch. A remote control unit is also available as an alternative, which is charged extra. The remote control unit incorporates one transmitter and one receiver which operate all the LED lamps. The footswitch is omitted when the remote control unit is employed.

Remote control

Surcharge for remote control
(transmitter + receiver) type



1601 = -

Surcharge for extra transmitter type

1602 = -

Surcharge for extra receiver type

1603 = -

Note on usable bed inside height:

The support slats of the hülsta beds are delivered in the centre position, i.e. they can be adjusted by 3.2 cm upwards and downwards. If the slats are set in the lowest position, the **maximum usable bed inside height** is achieved.

In the case of some beds, the bed inside height is comparatively low. This means that mattresses in combination with base frames that are somewhat higher are not held so well by the bed side sections. Please note that the usable bed inside height of beds with height adjustable support slats is reduced when these are set higher.

This is how to calculate the individual height from the data supplied with the base frames:

Example: bed and hülstaflex basic B base frame (back and foot sections adjustable)

Max. usable bed inside height:
18.0 cm



approx. 12.5 cm for holding mattress
5.5 cm total height of base frame (example: hülstaflex basic B)

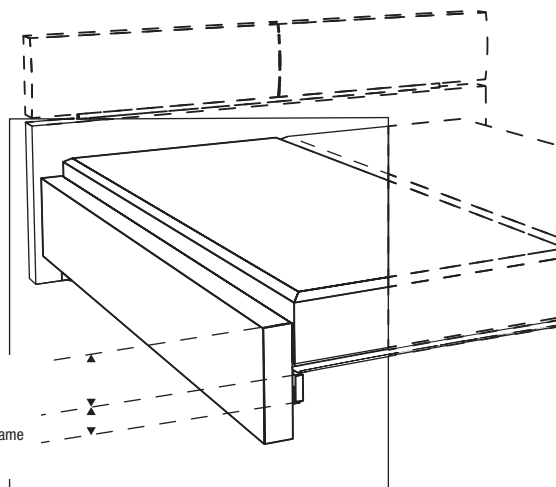

Note on space under bed:

The storage space underneath the base frame is calculated from the bed height minus the usable bed inside height.

Example bed: **42.2 cm - 18.0 cm = 24.2 cm.**

Special-sized products

Special heights, special widths, special depths

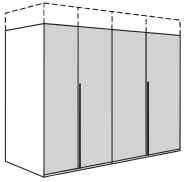

Special heights

- Hinge-, folding- and sliding-door wardrobes can be reduced in height at intervals of 1.0 cm.
- Below eye-level we recommend fitting a top cover shelf made of panelling material. Please state in order!
- Special heights in stepped versions (not possible on sliding-door wardrobes) at a surcharge.

Surcharge per step:

00030

-

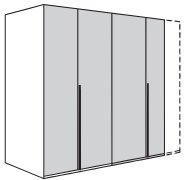

Special widths

Only applies to hinge- and folding-door wardrobes

- Single-door units, left or right hinges, can be reduced down to 25 cm width (apart from profiled doors).
- Twin-door units can be reduced at both sides down to 50 cm total width (apart from profiled doors).
- Interior fittings such as drawers and other fittings cannot be reduced in width.
- For notes on width reductions on MULTI-FORMA II sliding-door wardrobes please see special-sized products for MULTI-FORMA II!

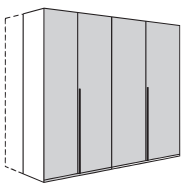

Special depths

- Depth reductions are made on side sections, plinths, cornices and shelves.
- Interior fittings such as drawers and other fittings cannot be reduced in depth.
- A max. reduction of 30.0 cm is possible on hinge- and folding-door wardrobes.
- A max. reduction of 9.0 cm is possible on profiled hinge-doors.
- For sliding-door wardrobes, a max. reduction of 30.0 cm is possible (max. 18 cm in combination with the electrical opening system for MULTI-FORMA II).
- Please note that for technical production reasons not every special depth can be achieved:
2.5 cm standard reduction between 0 and 2.5 cm
5.0 cm standard reduction between 4.5 and 5.0 cm
27.5 cm standard reduction between 27.0 and 27.5 cm

Notes on calculating sizes of sloping units

Side sloping

Sloping is only possible on single-door units. The door hinge (left or right) is positioned on the taller outer side of the unit.

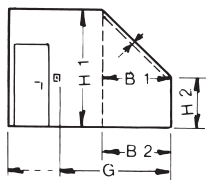
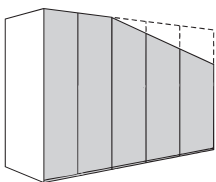

Measurements required:

- H 1 = Room height
- H 2 = Height of slope (If a space is required between the wall and the wardrobe/unit, please state the exact distance.)
- B 1 = Width of slope
- B 2 = Width of slope
- G = Total width
- S = Wardrobe width

Please note!

- If the slope cuts across the position of a handle, the handle of this door only is positioned further down in production.
- As floors, ceilings and walls are never exactly straight, the exact room size must be measured using a spirit level.
- If a cornice is fitted, please state if this is to be continued in the sloping section.

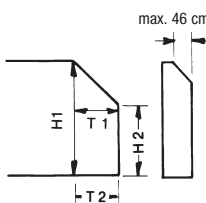
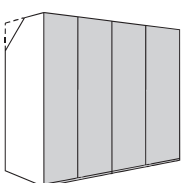

Rear sloping

Rear sloping is possible on all wardrobe units.

Measurements required:

- H 1 = Room height
- H 2 = Height of slope (If a space is required between the wall and the wardrobe/unit, please state the exact distance.)
- T 1 = Depth of slope
- T 2 = Depth of slope

FENA

Wardrobes

Special heights:

Hinge-door	- Wood	0003	without surcharge
Hinge-door	- Mirror	00031	without surcharge

Special widths:

for single-door unit	- Wood	0005	-
for single-door unit	- Mirror	00051	-
for twin-door unit	- Wood	0006	-
for twin-door unit	- Mirror	00061	-

When ordering extra fitted shelves and clothes rods

Size reduction surcharge per fitted shelf	9991	-
Size reduction surcharge per clothes rod	9992	-

Special depths:

Surcharge per unit	0007	-
--------------------	-------------	---

When ordering extra fitted shelves

Size reduction surcharge per fitted shelf	9993	-
---	-------------	---

Side sloping:

Surcharge per unit	9994	-
--------------------	-------------	---

Rear sloping:

Surcharge per unit	99912	-
--------------------	--------------	---

Beds

Bed in special length 190 cm	99964	-
Bed with two footboards (all-round bed)	99967	without surcharge

Special-sized products for special combinations:

Pricing: special combination + 15% plus all the required special-sized products (see above)

More special products are possible.

Please get in touch with your customer advisor.

Special articles

Wardrobe doors are also available as separate units and are charged as follows:

For 1 hinge-door/folding-door wing: 50% of the concerning 1-door hinge-door extension unit

For 1 sliding-door including mechanism: 35% of the twin-door sliding-door wardrobe

For door superstructures, type **100** (max. 98 cm wide, only for assembly between wardrobes): 100% of twin-door hinge-door extension unit

Panels for side and top covering of fitted wardrobes (support construction and fitting materials must be acquired on site).

For veneered/lacquered versions (max. 268.0 cm long, max. 59.0 cm wide, 2.0 cm thick)

Basis charge per order:	9901	-
+ price per m ² - lacquer	990	-
+ price per m ² - veneer	990	-

Veneer match with fronts can not be guaranteed.

Edge veneer

for veneered/lacquered versions per m. length	9902	-
---	-------------	---

165° hinges

Wardrobe doors can also be fitted with **165° hinges** against a surcharge (only possible on plain, straight hinge-doors). Please mark the doors clearly in the order!

Surcharge for 165° hinges per hinge-door:	180	-
---	------------	---

Individual special-sized products

If the special-sized product that you require is so unusual that it cannot be illustrated with the many special sized products that we already provide and charge for, then we will quote you the price using a 33 unit type factor. In your order please state for us the relevant enquiry number and the 33 unit type factor stated.

	33	-
--	-----------	---

Special colours; Note on „Blue Angel“ / Emissions label of DGM

Special colours

All the hülsta lacquer colours are possible for nearly all the hülsta ranges. Availability and prices on request.

Note on „Blue Angel“ (RAL-UZ 38) and Emissions label of DGM (Class A)

It is possible that the requirements of the „Blue Angel“ and the DGM Emissions Label cannot be met by some of the lacquer colours in price groups III and IV (see here the different lacquer versions in the NEO range), depending on the colour mix (surface ratio of these colours in the corresponding order). However, the legal requirements are definitely met in all cases!

Important notes

Wall composition / assembly instruction

Important notes:

The composition of walls must be ascertained before concluding a contract and be checked by a qualified fitter before assembly takes place.









Assembly may only be carried out by a qualified fitter under careful observation of the assembly instructions.

The plastic Rawl plugs supplied by hülsta as a standard set are only suitable for concrete \geq C12/15, if the wall composition and compression strength corresponds to the table below. Under no circumstances must a unit be assembled on light masonry.

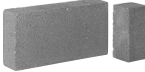
Furthermore, we provide a mounting set with assembly mortar for the types of walls listed below (see assembly mortar set below). Again, assembly must be carried out by a qualified fitter under careful observation of the wall composition and assembly instruction. The compression strength levels stated below must be met under all circumstances.

Materials table

with a description of which sets are to be used with the following types of walls:

Standard set	Assembly mortar set only suitable for the materials stated below!	
Concrete C12/15 Compression strength \geq 15 N/mm ² 	 Building bricks Mz 12 Compression strength \geq 12 N/mm ²	 Solid blocks of light concrete V2 Compression strength \geq 2 N/mm ²
	 Limestone blocks KS 12 Compression strength \geq 12 N/mm ²	 Perforated blocks of light concrete Hbl 2 Compression strength \geq 2 N/mm ²
	 Perforated sand lime bricks KSL12 Compression strength \geq 12 N/mm ²	 Aerated concrete PP2 Compression strength \geq 2 N/mm ²
	 Vertically perforated bricks HLz 12 Compression strength \geq 12 N/mm ² Bulk density \geq 1.0 kg/dm ³	

A different and more suitable type of mounting must be chosen by a qualified fitter in all other cases. hülsta cannot accept any responsibility for the choice of any other types of mounting! Please note that if the units are not mounted properly on the wall, there is a risk of the units falling down or tipping over – especially when alternative mounting materials acquired on site have been used. Generally speaking, you as a dealer/qualified fitter are responsible for the correct wall mounting of the units.



Mounting sets

Labelling in type list drawings / assembly notes for wall units

The majority of units have two wall mounting points (= number of support boards), if these are to be fitted as wall units. This is not explicitly mentioned in the type list. If a different number of wall mounting points (= support boards) is required, this is marked in the drawings in the type list with numbers in black boxes. Every support board requires four mounting screws.

- 3** = 3 support boards
- 4** = 4 support boards, etc.

One **assembly mortar set** is sufficient for up to a maximum of 3 support boards or 4 wall side-panels.

Important note: Depending on the composition of the wall (see wall types illustrated above), assembly must be carried out using the special assembly mortar set and a standard trade mastic tool which are the basic essentials for safe and clean workmanship.

Standard set

The standard set consists of 4 plastic Rawl plugs and 4 mounting screws and is sufficient for 1 support board. The standard sets are included in the packet of fittings to match the number of support boards.

Assembly mortar set for up to a maximum of 3 support boards consisting of:

- 9x injection retaining sleeve
- 9x screw-in sleeve
- 1x injection cartridge
- 2x static mixer
- 1x assembly instructions

Please use the mounting screws from the standard set (supplied free of charge).

Example of order:

- Add up number of support boards for all existing unit types
 - Divide the sum by “3”
 - Round up the result to a full number
- = Number of assembly mortar sets required

M2

Your Hotline to hülsta

Do you have any questions or require any alterations to your order confirmation?
Do you have any questions on our products or your current order?
Do you have any complaints about supplied goods or required replacement parts?
Contact Telephone: +49 (0) 2563 / 86-1627 • email: orders@huelsta.com

Do you have any questions, suggestions or wishes for the **hülsta product seminars**?
Contact Telephone: +49 (0) 2563 / 86-1493 • email: produktschulungen@huelsta.de

hülsta Planning Service

Lots to do? A customer wants his project finished and you haven't got enough time? Or the project is so complex that it will take too much time?

This is exactly the kind of situation we created the hülsta Planning Service for. hülsta's employees create the required project for you at short notice. Based on your information, we implement the project perfectly with all views and a complete order list ready for immediate forwarding to the customer.

The hülsta check list (available at <https://www.huelsta.com/einrichtungsberatung/>) makes it all really easy for you. You won't forget anything with this list and the customer receives a project he will be thrilled about as quickly as possible.

hülsta Planning Service

Tel.: +49 (0) 2563 / 86-1060

Fax: +49 (0) 2563 / 86-1000

Mail: Planungsservice-Handel@huelsta.de

Workdays from 8.00 a.m. until 6.00 p.m.

Special wishes? Come to us!

Maximum individuality! – Maximal flexibility! – hülsta makes most of your special wishes possible.
And if you do have a wish which is not quite so easy to implement, just give us a call or send us a mail or a fax. We have our own hülsta "Special Wishes Team" who are there to help you realise just these customer requests. These colleagues are professionals when it comes to special products. They plan and calculate the products possible for you and even develop an alternative suggestion if the idea should turn out to be technically impossible.

Here is an overview of the hülsta range of special wishes:

- A lot of special products can be ordered simply via the type list
- Special-sized products are planned simply and professionally
- Competent colleagues advise you by phone, by fax and by mail
- You will be sent alternative suggestions if the idea is technically impossible
- Many special-sized products are available without a surcharge
- Specially qualified carpenters and technicians implement your plans perfectly

hülsta Special Wishes Team

Tel.: +49 (0) 2563 / 86-1060

Fax: +49 (0) 2563 / 86-1417

Mail: Sonderwunsch@huelsta.com

We are open Saturdays for you, too!

Our **Saturday hotline** is available at the following times and periods:

- **15th April – 15th September** from 10.00 a.m. until 4.00 p.m.
- **16th September – 14th April** from 10.00 a.m. until 6.00 p.m.

Telephone: +49 (0) 2563 / 86-1800

On **working days** the hülsta Sales Department is available all day from **8.00 a.m. until 6.00 p.m.**

hülsta FENA Schlafen

Stand: E 4. 2020

Design and concept legally protected, subject to error and alterations to construction, colour and materials by way of technological progress.

hülsta-werke · Karl-Hüls-Straße 1 · D-48703 Stadthoorn
Tel. +49 (0) 2563 / 86-0 · Fax +49 (0) 2563 / 86-1000
www.huelsta.com

hülsta 